



EC900-FS6

Fanless Embedded System

User's Manual

Copyright

This publication contains information that is protected by copyright. No part of it may be reproduced in any form or by any means or used to make any transformation/adaptation without the prior written permission from the copyright holders.

This publication is provided for informational purposes only. The manufacturer makes no representations or warranties with respect to the contents or use of this manual and specifically disclaims any express or implied warranties of merchantability or fitness for any particular purpose. The user will assume the entire risk of the use or the results of the use of this document. Further, the manufacturer reserves the right to revise this publication and make changes to its contents at any time, without obligation to notify any person or entity of such revisions or changes.

Changes after the publication's first release will be based on the product's revision. The website will always provide the most updated information.

© 2019. All Rights Reserved.

Trademarks

Product names or trademarks appearing in this manual are for identification purpose only and are the properties of the respective owners.

FCC and DOC Statement on Class A

This equipment has been tested and found to comply with the limits for a Class B digital device, pursuant to Part 15 of the FCC rules. These limits are designed to provide reasonable protection against harmful interference when the equipment is operated in a residential installation. This equipment generates, uses and can radiate radio frequency energy and, if not installed and used in accordance with the instruction manual, may cause harmful interference to radio communications. However, there is no guarantee that interference will not occur in a particular installation. If this equipment does cause harmful interference to radio or television reception, which can be determined by turning the equipment off and on, the user is encouraged to try to correct the interference by one or more of the following measures:

- Reorient or relocate the receiving antenna.
- Increase the separation between the equipment and the receiver.
- Connect the equipment into an outlet on a circuit different from that to which the receiver is connected.
- Consult the dealer or an experienced radio TV technician for help.

Notice:

1. The changes or modifications not expressly approved by the party responsible for compliance could void the user's authority to operate the equipment.
2. Shielded interface cables must be used in order to comply with the emission limits.

Table of Contents

About this Manual.....	4	Chapter 5 - Ports and Connectors.....	14
Warranty	4	Panel I/O Ports.....	14
Static Electricity Precautions	4	RJ45 LAN Ports	15
Safety Measures.....	4	9~36V DC-in	15
Safety Precautions	5	USB Ports.....	16
About the Package.....	5	Serial Port.....	16
Before Using the System	5	Graphics Interface.....	17
Chapter 1 - Introduction.....	6	I/O Connectors.....	17
Overview.....	6	Digital I/O Connector.....	17
Key Features	6	Serial Port.....	18
Specifications.....	7	Expansion Slots	19
Getting to Know the EC900-FS6	8	I ² C Connector	19
Mechanical Dimensions	9	Front Panel Connector	20
Chapter 2 - Getting Started.....	10	Battery	20
Chapter 3 - Installing Devices.....	11	Debug Connectors	21
Removing the Chassis Cover.....	11	Chapter 6 - Mounting Options	22
Chapter 4 - Jumper Settings.....	13	Chapter 7 - Supported Software	23
Boot Mode Select.....	13		

About this Manual

An electronic file of this manual can be obtained from the DFI website at www.dfi.com. To download the user's manual from our website, please go to Support > Download Center. On the Download Center page, select your product or type the model name and click "Search" to find all technical documents including the user's manual for a specific product.

Warranty

1. Warranty does not cover damages or failures that arised from misuse of the product, inability to use the product, unauthorized replacement or alteration of components and product specifications.
2. The warranty is void if the product has been subjected to physical abuse, improper installation, modification, accidents or unauthorized repair of the product.
3. Unless otherwise instructed in this user's manual, the user may not, under any circumstances, attempt to perform service, adjustments or repairs on the product, whether in or out of warranty. It must be returned to the purchase point, factory or authorized service agency for all such work.
4. We will not be liable for any indirect, special, incidental or consequential damages to the product that has been modified or altered.

Static Electricity Precautions

It is quite easy to inadvertently damage your PC, system board, components or devices even before installing them in your system unit. Static electrical discharge can damage computer components without causing any signs of physical damage. You must take extra care in handling them to ensure against electrostatic build-up.

1. To prevent electrostatic build-up, leave the system board in its anti-static bag until you are ready to install it.
2. Wear an antistatic wrist strap.
3. Do all preparation work on a static-free surface.
4. Hold the device only by its edges. Be careful not to touch any of the components, contacts or connections.
5. Avoid touching the pins or contacts on all modules and connectors. Hold modules or connectors by their ends.



Important:

Electrostatic discharge (ESD) can damage your processor, disk drive and other components. Perform the upgrade instruction procedures described at an ESD workstation only. If such a station is not available, you can provide some ESD protection by wearing an antistatic wrist strap and attaching it to a metal part of the system chassis. If a wrist strap is unavailable, establish and maintain contact with the system chassis throughout any procedures requiring ESD protection.

Safety Measures

To avoid damage to the system:

- Use the correct AC input voltage range.

To reduce the risk of electric shock:

- Unplug the power cord before removing the system chassis cover for installation or servicing. After installation or servicing, cover the system chassis before plugging the power cord.

Battery:

- Danger of explosion if battery incorrectly replaced.
- Replace only with the same or equivalent type recommend by the manufacturer.
- Dispose of used batteries according to local ordinance.

Safety Precautions

- Use the correct DC input voltage range.
- Unplug the power cord before removing the system chassis cover for installation or servicing. After installation or servicing, cover the system chassis before plugging the power cord.
- Danger of explosion if battery incorrectly replaced.
- Replace only with the same or equivalent type recommend by the manufacturer.
- Dispose of used batteries according to local ordinance.
- Keep this system away from humidity.
- Place the system on a stable surface. Dropping it or letting it fall may cause damage.
- The openings on the system are for air ventilation to protect the system from overheating. **DO NOT COVER THE OPENINGS.**
- Place the power cord in such a way that it will not be stepped on. Do not place anything on top of the power cord. Use a power cord that has been approved for use with the system and that it matches the voltage and current marked on the system's electrical range label.
- If the system will not be used for a long time, disconnect it from the power source to avoid damage by transient overvoltage.
- If one of the following occurs, consult a service personnel:
 - The power cord or plug is damaged.
 - Liquid has penetrated the system.
 - The system has been exposed to moisture.
 - The system is not working properly.
 - The system dropped or is damaged.
 - The system has obvious signs of breakage.
- The unit uses a three-wire ground cable which is equipped with a third pin to ground the unit and prevent electric shock. Do not defeat the purpose of this pin. If your outlet does not support this kind of plug, contact your electrician to replace the outlet.
- Disconnect the system from the DC outlet before cleaning. Use a damp cloth. Do not use liquid or spray detergents for cleaning.

About the Package

The package contains the following items. If any of these items are missing or damaged, please contact your dealer or sales representative for assistance.

- One EC900-FS6 system unit
- One Quick Installation Guide

Optional Items

- DIN-rail Mount kit
- Power Cord

The board and accessories in the package may not come similar to the information listed above. This may differ in accordance to the sales region or models in which it was sold. For more information about the standard package in your region, please contact your dealer or sales representative.

Chapter 1 - Introduction

Overview



Front View

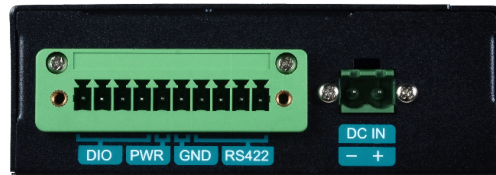

Left View

Key Features

Model Name	EC900-FS6
Processor	NXP i.MX6 Series Processor NXP i.MX6 Cortex-A9 Dual Lite, 1.0GHz
LAN	Two LAN ports
COM	Two serial port: 2-wire RS485 4-wire RS422
Display	One HDMI
USB	Two USB 2.0 Type A ports
Digital input/output	Terminal block for digital I/O with power

Specifications

Processor System	NXP i.MX6 Series Processor NXP i.MX6 Cortex-A9 Dual Lite, 1.0GHz
Memory	<ul style="list-style-type: none"> 1GB/2GB SDRAM Memory Down Single Channel DDR3L 1600MHz
Graphics	<ul style="list-style-type: none"> Display interface HDMI: resolution up to 1920x1080 @ 60 Hz
Storage/Expansion	<ul style="list-style-type: none"> Storage 4MB NOR Flash 8GB/16GB eMMC Expansion: 1 x Full-size Mini PCIe (PCIe/USB) 1 x microSD
Ethernet	<ul style="list-style-type: none"> 1 x Atheros Ethernet Controller AR8033-AL1B (10/100/1000Mbps) 1 x Microchip's USB to Ethernet Controller LAN7500-ABZJ (10/100/1000Mbps)
I/O Ports and LED Indicators	<ul style="list-style-type: none"> Front Panel <ul style="list-style-type: none"> - 2 x RJ-45 LAN ports - 1 x RS-485 (2-wire terminal block) - 2 x USB 2.0 (type A) - 1 x HDMI - 1 status LED - 1 reset button Side Panel <ul style="list-style-type: none"> - 1 x RS-422 (4-wire terminal block) - 1 x DIO (with power) connector (6-wire terminal block)
Power	<ul style="list-style-type: none"> 9~36V DC-in
Environment	<ul style="list-style-type: none"> Temperature <ul style="list-style-type: none"> - Operating: -20°C ~ 60°C -40°C ~ 70°C - Storage: -40 to 85°C Relative Humidity <ul style="list-style-type: none"> - 10% to 90% RH (non-condensing)

Vibration	<ul style="list-style-type: none"> Operating: Random 5~500Hz, IEC68-2-64 (3G) Non-Operating: Sine 10~500Hz, IEC68-2-6 (3G)
Shock	<ul style="list-style-type: none"> Operating: 3G, 11ms Non-Operating: 5G, 11ms
Construction	<ul style="list-style-type: none"> Sheet Metal
Mounting	<ul style="list-style-type: none"> DIN-rail Mount
Dimensions	<ul style="list-style-type: none"> 145mm x 34mm x 96.4mm (W x H x D)
Weight	<ul style="list-style-type: none"> 0.5 kg
OS Support	<ul style="list-style-type: none"> Yocto 1.8 beta, Kernel 3.14.52 Android 5.1 beta, Kernel 3.14.52

Getting to Know the EC900-FS6

Front View

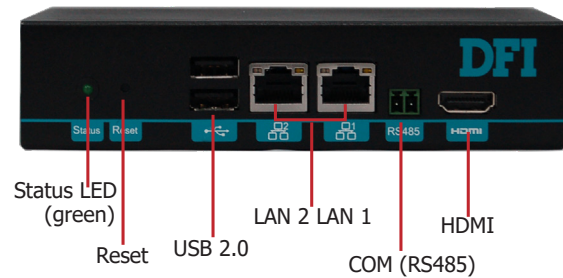

Status LED (blue)

This LED will blink when the system is in the standby mode.

Status LED			
Suspend Mode	S0	Sleep	S4, S5
LED Behavior	On	Blinking	Off

Reset Button

Press to reset the system without disconnecting the system's power.

USB 2.0 Ports

Connect USB 2.0 and 1.1 devices.

LAN Ports

Connect the system to a local area network.

RS485 Port

Connects RS485 devices.

HDMI Port

Connects the HDMI port of a display device.

Rear View

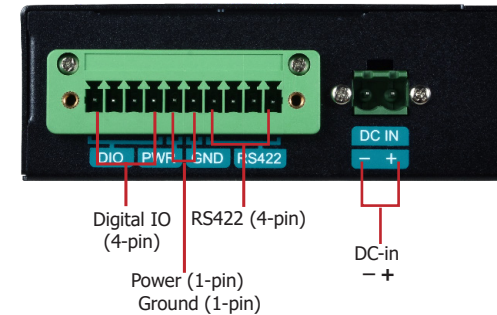

DC-in Connector

DC 9~36V power input via a terminal block connector.

DIO Connector with Power

Provides 4-bit digital input/output with power connectivity (2-pin).

RS422 Port

Connects RS422 devices.

Mechanical Dimensions

Chassis Dimension

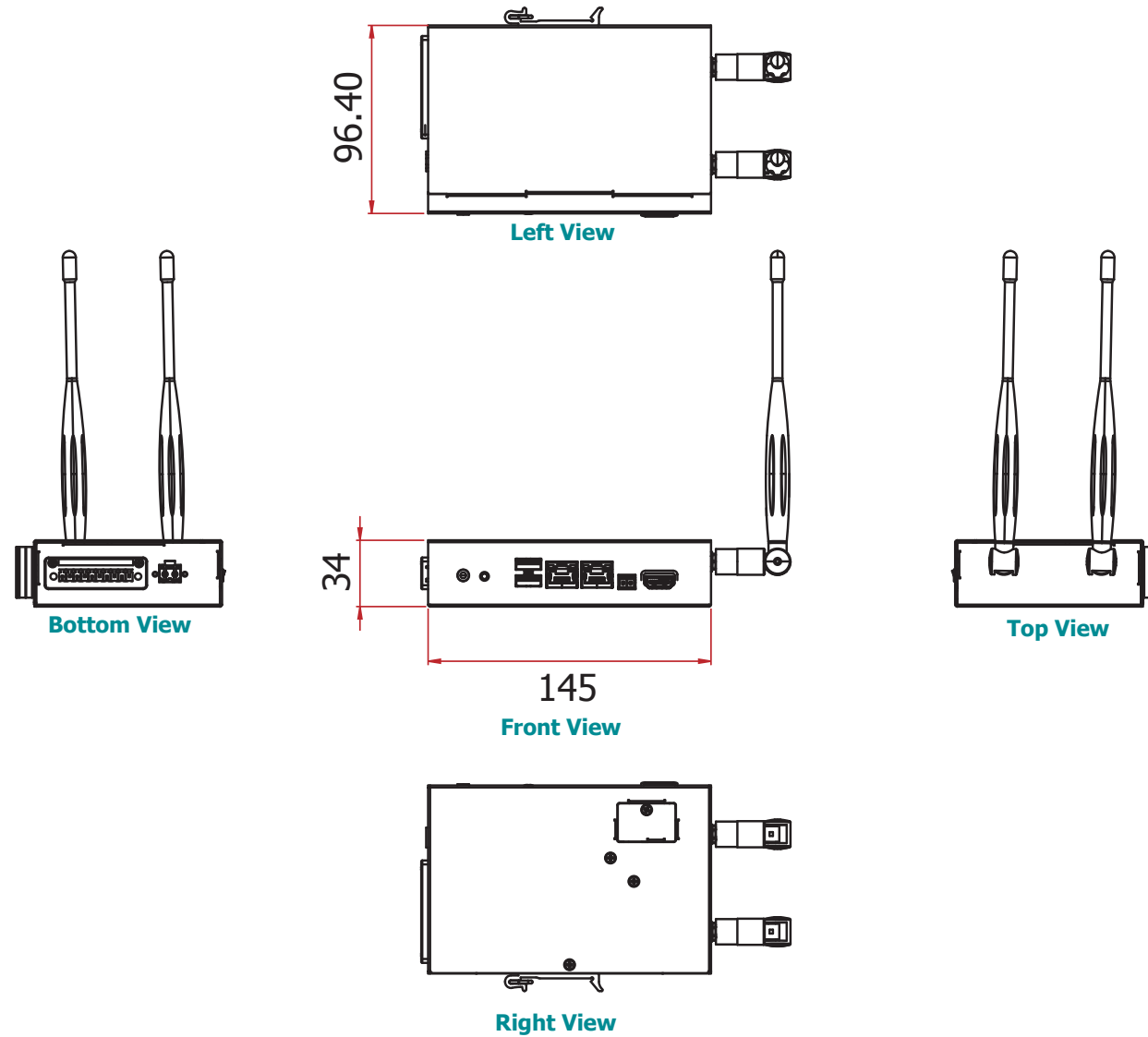

Chapter 2 - Getting Started

Preparing the System

Before you start using the system, you need the following items:

- AC power cord
- Screwdriver

Installing Devices

The following devices can be installed in the system.

- Mini PCIe card
- micro SD

Configuring the BIOS

To get you started, you may need to change configurations such as the date, time and the type of hard disk drive.

1. Power on the system.
2. After the memory test, the message "Press DEL to run setup" will appear on the screen. Press the Delete key to enter the BIOS setup utility.

Installing the Operating System

The device platform is an embedded system with Yocto 1.8 beta or Android 5.1 beta pre-loaded on the eMMC.

Chapter 3 - Installing Devices

Removing the Chassis Cover

Please observe the following guidelines and follow the procedure to open the system.

1. Make sure the system and all other peripheral devices connected to it have been powered off.
2. Disconnect all power cords and cables.
3. The 3 mounting screws on the rear and bottom sides of the system are used to secure the cover to the chassis. Remove these screws and put them in a safe place for later use.

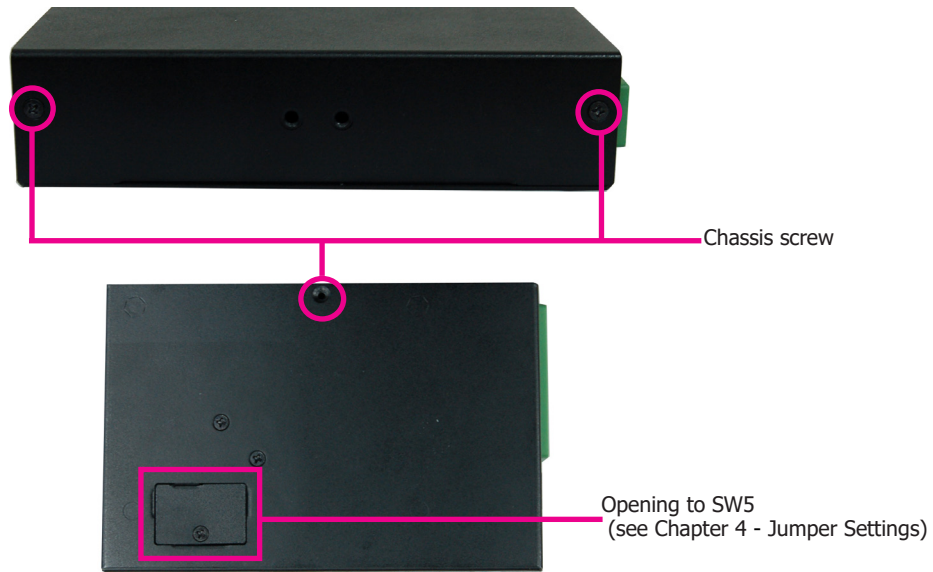

4. Lift the cover to open the system. The Mini PCIe socket is readily accessible after removing the bottom cover.

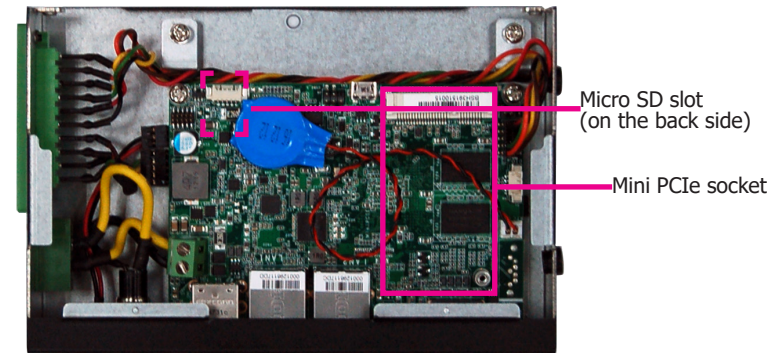

Installing a Mini PCIe Card

The system board is equipped with one Mini PCIe slot that supports both PCIe and USB signals.

1. Grasp the Mini PCIe card by its edges and align the notch of the PCIe card with the key in the connector on the system board.
2. Push down on the other end of the Mini PCIe card and use the provided mounting screw to secure the card on the system board.

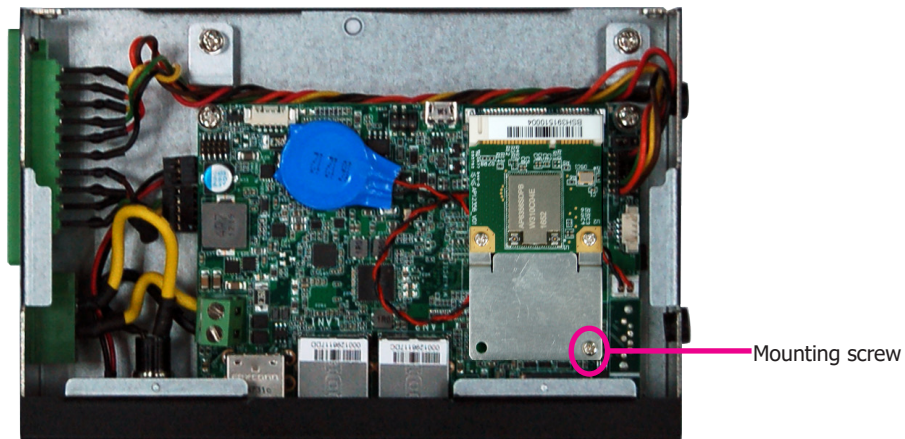

3. Push down on the other end of the Mini PCIe card and use the provided mounting screw to secure the card on the system board.

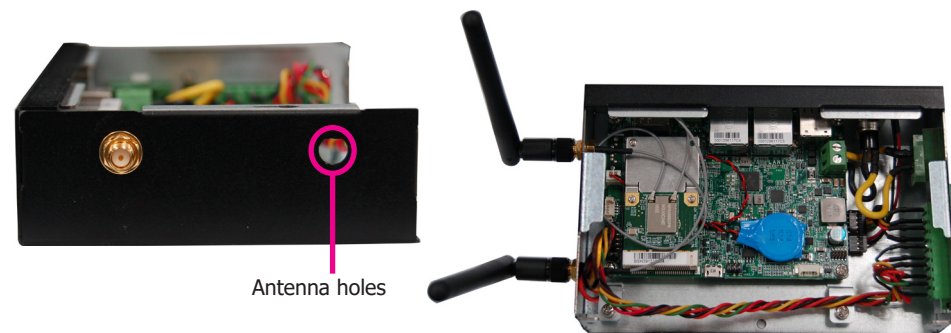

Note:

If installing a wireless module, place the antenna cable(s) on top of the Mini PCIe and route the cables to the side of the chassis to reach the antenna holes.

Chapter 4 - Jumper Settings

Boot Mode Select

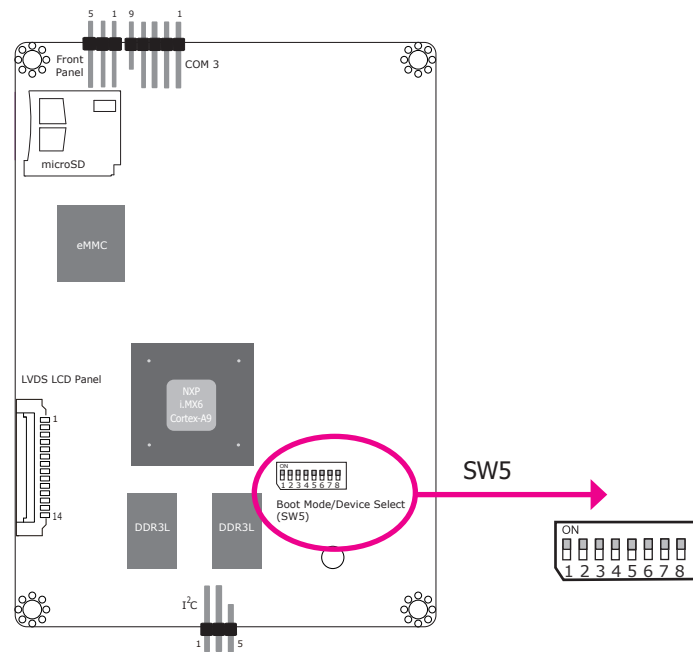

To select the boot mode and boot device, please use finger switch SW5.

Boot Mode Select	SW5
Boot from the fuses	7 Off, 8 Off
Serial downloader	7 On, 8 Off
Boot from the board settings (default)	7 Off, 8 On
Reserved	7 On, 8 On

Boot Device Select	SW5							
	1	2	3	4	5	6	7	8
eMMC	On	On	Off	Off	On	On	Off	On
SPI	xx	xx	xx	On	On	Off	Off	On
SD	On	Off	On	Off	Off	On	Off	On

Chapter 5 - Ports and Connectors

Panel I/O Ports

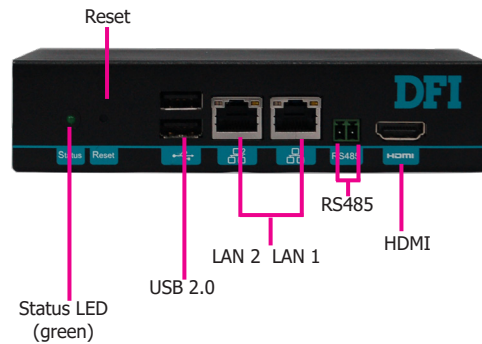

The front panel I/O consists of the following ports:

- Status LED (green)
- Reset button
- Two USB 2.0 ports
- Two RJ45 LAN ports
- COM (RS485) port
- HDMI port

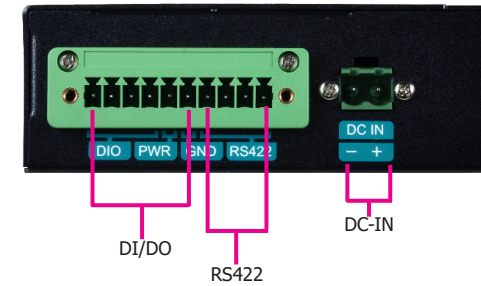

The left panel I/O port consists of the following ports:

- 4-pole digital input/output with power (2-pole)
- 4-pole COM (RS422) port
- DC-in connector

RJ45 LAN Ports

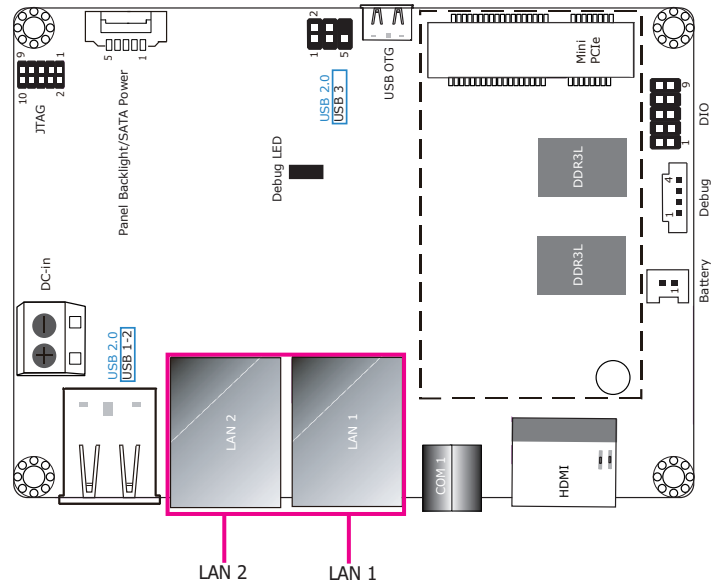

9~36V DC-in

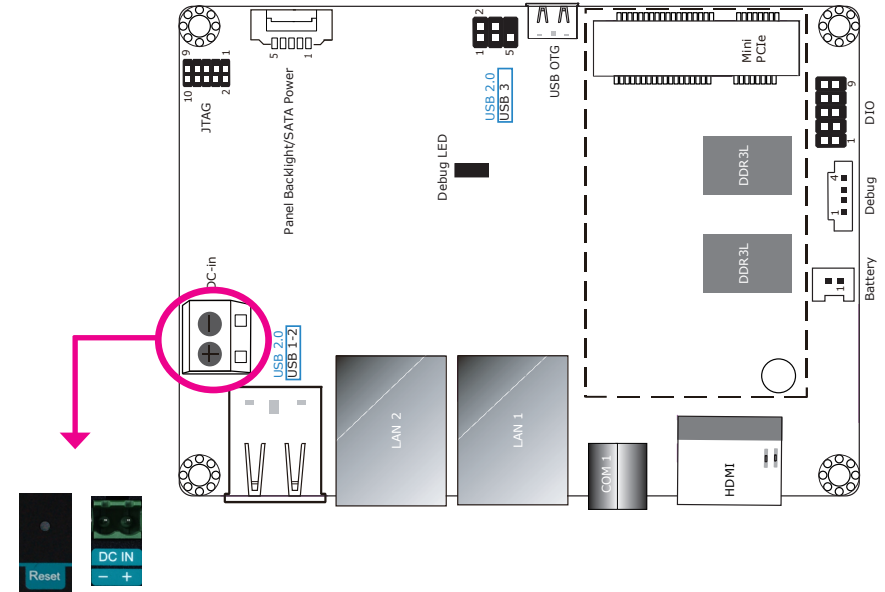

Features

- 2 LAN ports built on Atheros Ethernet PHY AR8033-AL1B (10/100/1000Mbps) and Microchip USB to Ethernet Controller LAN7500-ABZJ (10/100/1000Mbps)
 LAN 1: Atheros Ethernet PHY AR8033-AL1B (10/100/1000Mbps)
 LAN 2: Microchip USB to Ethernet Controller LAN7500-ABZJ (10/100/1000Mbps)

The LAN ports enable the system board to connect to a local area network with a network hub.

This 2-pin terminal block is considered a low power solution. This connector is wired as an external DC-in connector and reset button for power control. Please note that using a voltage more than the recommended range may fail to boot the system or cause damage to the system board.

The reset button allows you to reboot the system without powering off the system first.

USB Ports

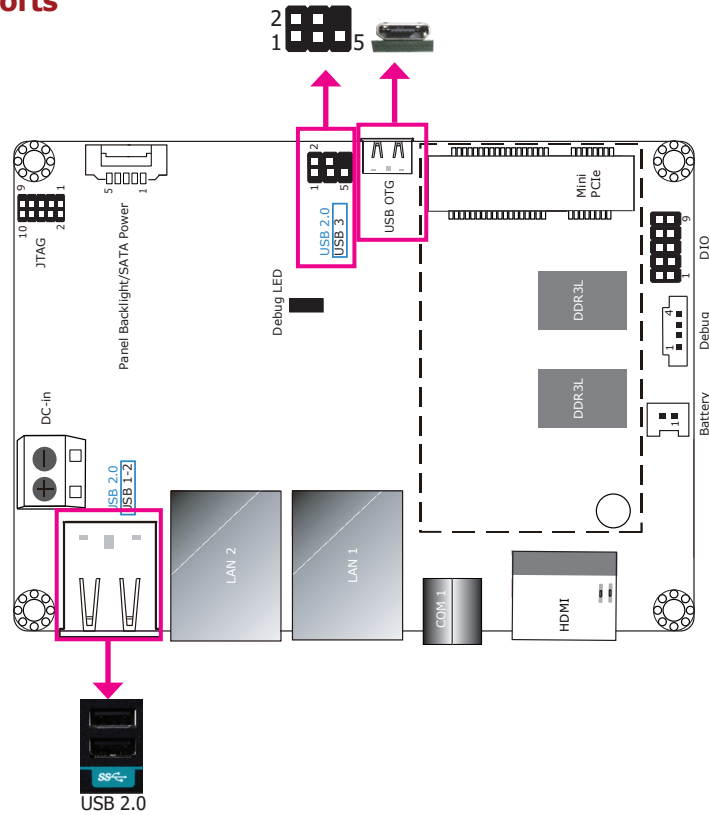

The USB 2.0 ports (USB 1-3) and OTG connector are used for USB communication. In addition, the USB OTG allows the board and the devices connected to it to switch back and forth between the roles of host and device.

When the system board is in host mode, it acts as a computer and allows USB peripherals to be connected through the USB OTG port. When the system board is in device mode, it acts as a peripheral device connecting to a host computer. And in this mode, the system board can read and write to the onboard eMMC memory from your host computer by using a micro-B type USB cable.

Pin	Pin Name
1	5V
2	Data-
3	Data+
4	GND
5	NC

Serial Port

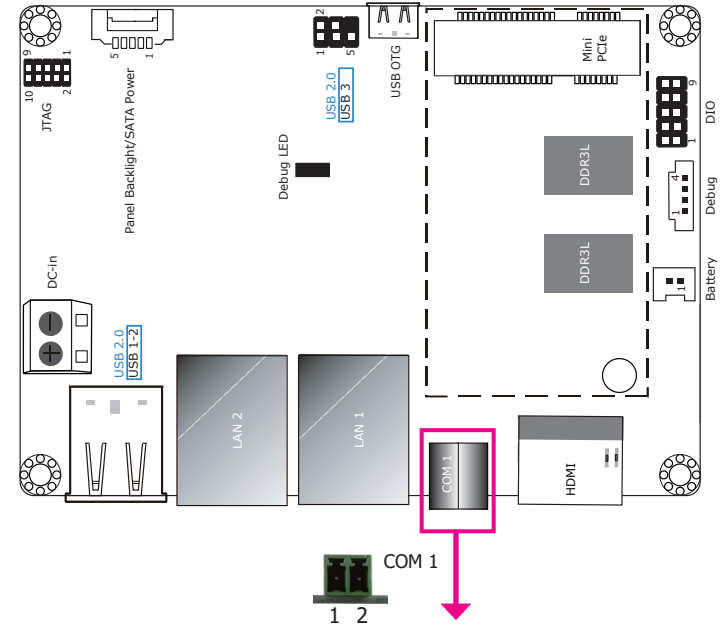

The COM 1 port provides 2-wire RS485 communication with support for auto flow control.

Pin	Pin Name	Pin	Pin Name
1	RS485+	2	RS485-

Graphics Interface

The display port consists of the following:

- 1 HDMI port

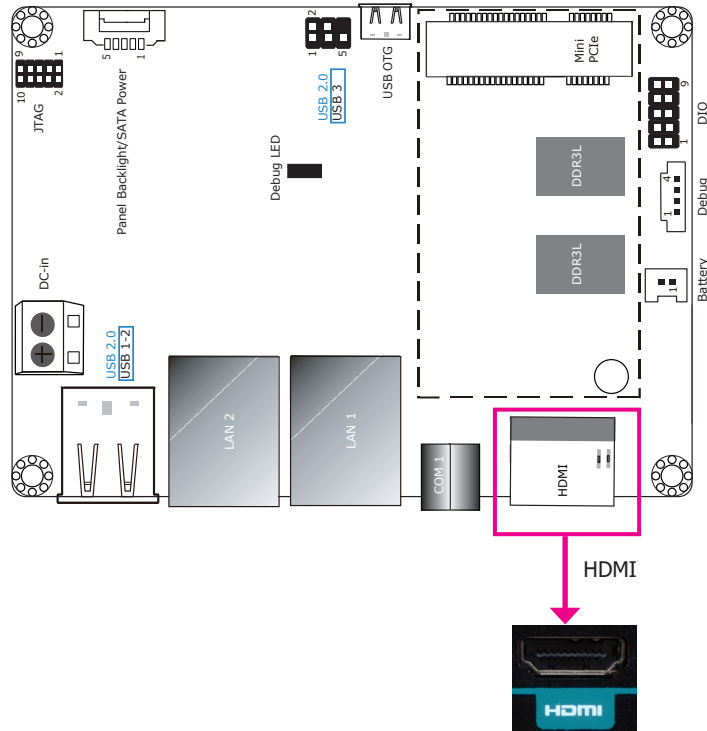

The HDMI port which carries both digital audio and video signals is used to connect the HDMI port of an LCD monitor or a digital TV.

The system supports dual and triple display with these ports.

I/O Connectors Digital I/O Connector

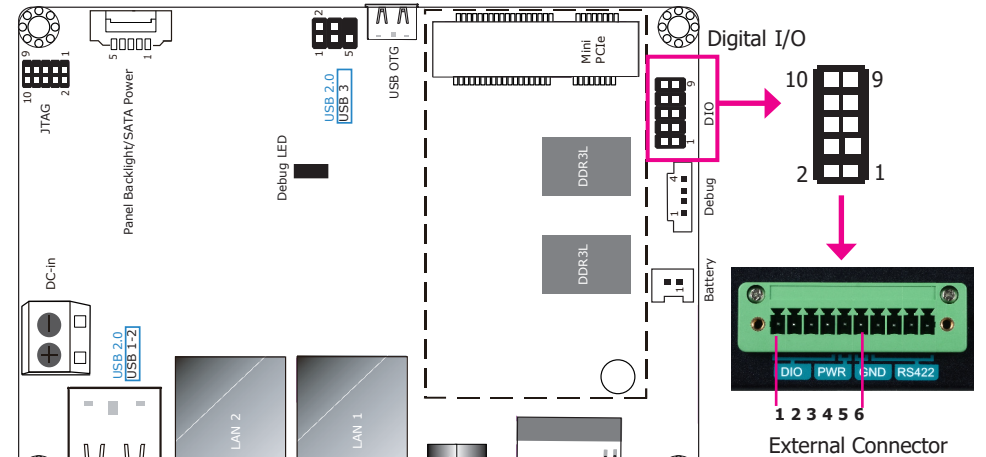

The internal digital I/O connector supports 8-bit digital input/output with power connectivity to provide monitoring and control function of the devices connected to the DIO port.

Internal DIO Connector

Pin	Pin Name
1	GPIO7
2	GPIO6
3	GPIO5
4	GPIO4
5	GPIO3
6	GPIO2
7	GPIO1
8	GPIO0
9	3.3V
10	GND

External DIO Connector

Pin	Pin Name
1	DIO7
2	DIO6
3	DIO5
4	DIO4
5	PWR (3.3V)
6	GND (ground)

Serial Port

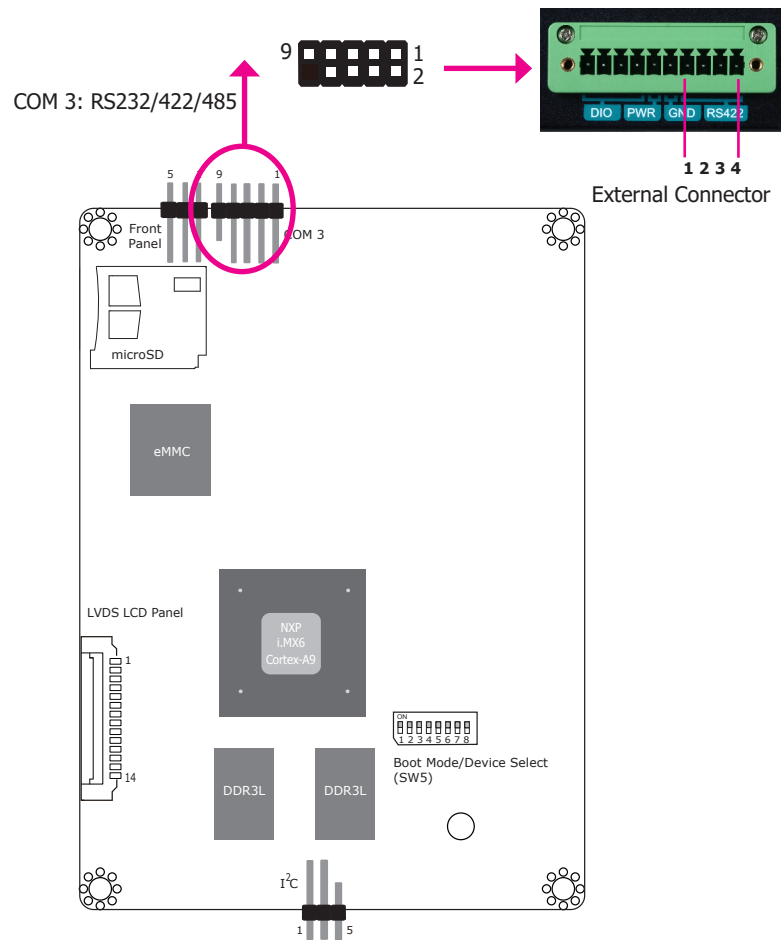

Pin	External RS-422
1	TX_B
2	TX_A
3	RX_A
4	RX_B

COM 3 can be used for RS232, RS422 or RS485 communication. And the RS485 supports auto flow control. This internal connector is wired as an RS-422 external port.

The serial port is asynchronous communication ports with 16C550A-compatible UARTs that can be used with modems, serial printers, remote display terminals, and other serial devices.

Expansion Slots

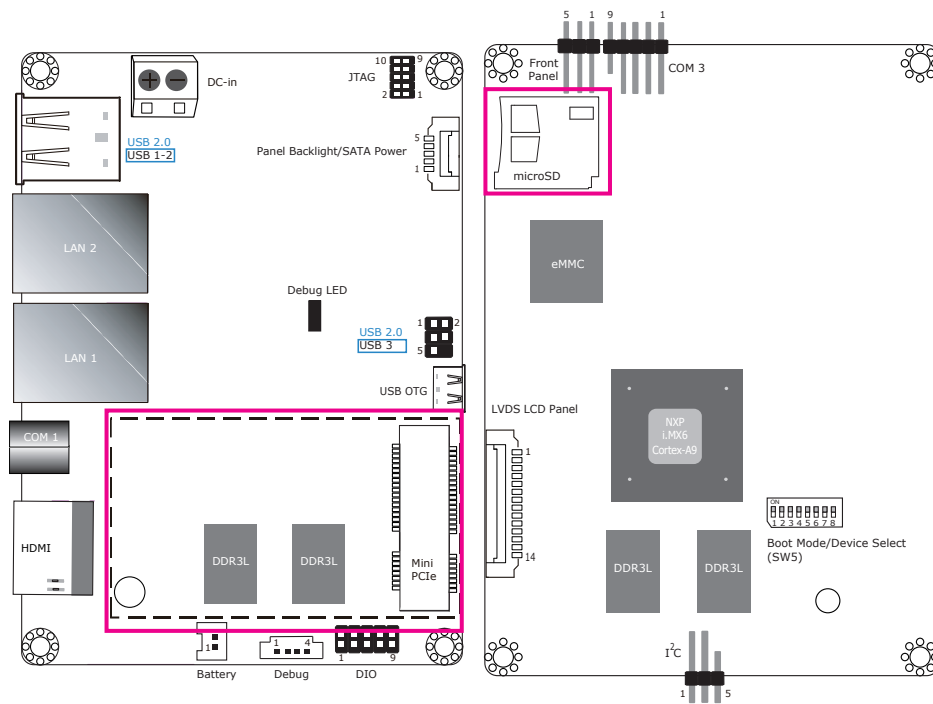

Mini PCI Express Slot

The full-size Mini PCIe socket supports PCIe x1 signals and is used to install a Mini PCIe card.

microSD Socket (on the back side)

The microSD socket allows you to install a microSD card for the expansion of available storage.

I²C Connector

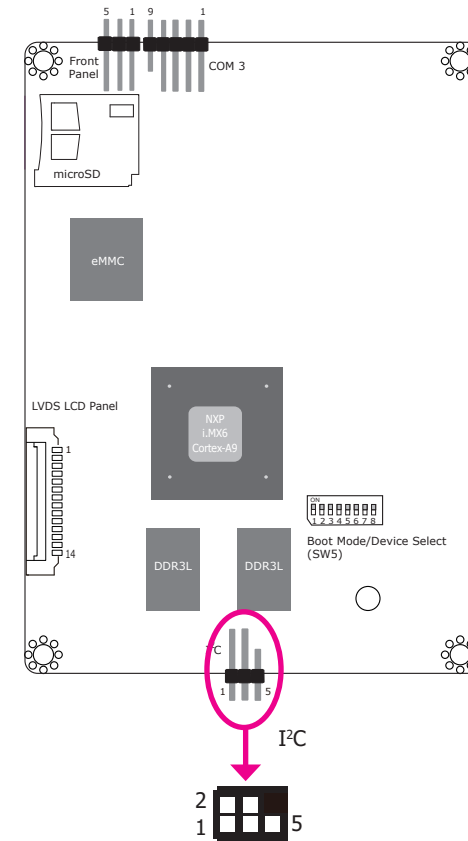

The I²C connector is used to monitor or communicate with system components which does not require high speed communication.

Pin	Pin Name
1	3.3V
2	GND
3	I2C_Clock
4	I2C_ALERT-
5	I2C_DATA

Front Panel Connector

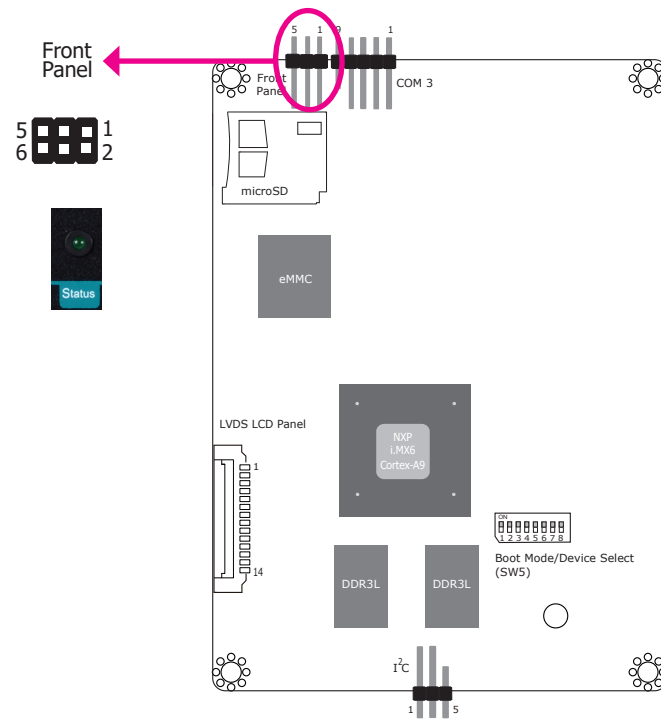

Status LED

The front panel connector includes a reset button and a power LED.

Pin	Pin Name	Pin	Pin Name
1	NC	2	Power_LED
3	GND	4	NC
5	Reset Button	6	NC

Battery

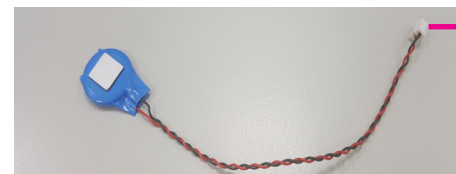
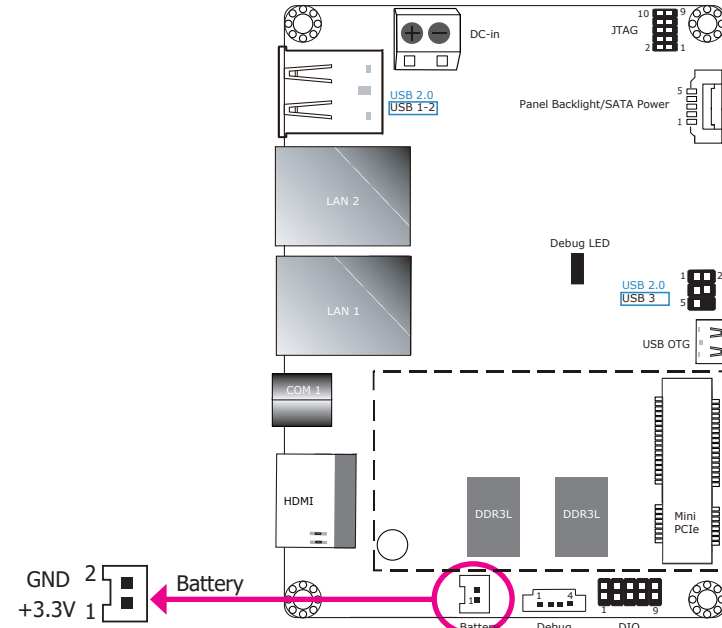

Connect to the battery connector

The lithium ion battery powers the real-time clock and CMOS memory. It is an auxiliary source of power when the main power is shut off.

Safety Measures

- Danger of explosion if battery incorrectly replaced.
- Replace only with the same or equivalent type recommend by the manufacturer.
- Dispose of used batteries according to local ordinance.

Debug Connectors

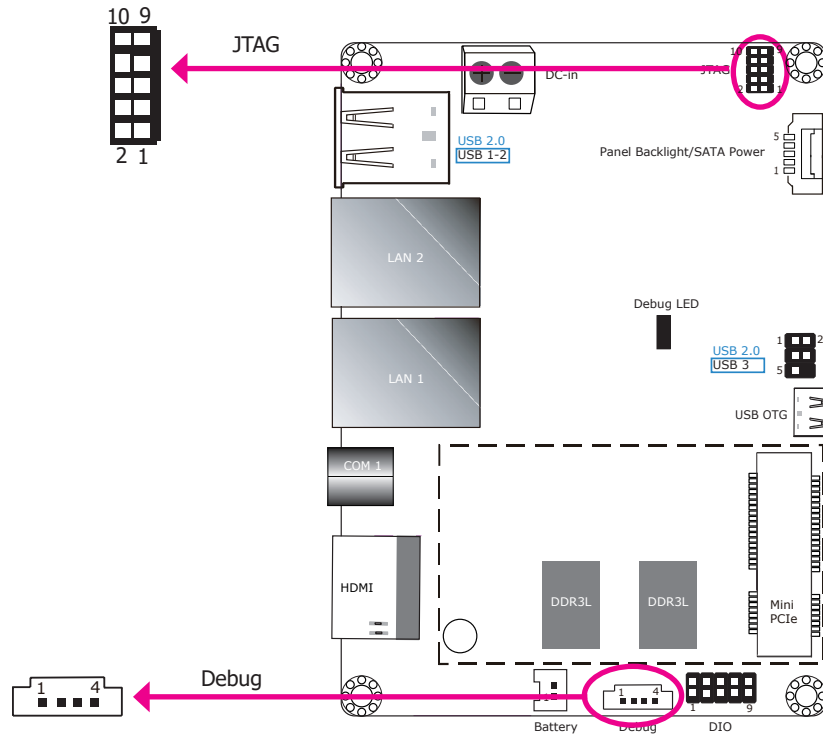

The JTAG and debug connectors are used for debugging purposes.

Debug Connector

Pin	Pin Name
1	3.3V
2	UART5_RX
3	UART5_TX
4	GND

JTAG Connector

Pin	Pin Name	Pin	Pin Name
1	3.3V	2	JTAG_TMS
3	GND	4	JTAG_TCK
5	GND	6	JTAG_TDO
7	JTAG_MOD	8	JTAG_TDI
9	JTAG_nTRST	10	JTAG_nRESET

Chapter 6 - Mounting Options

DIN-rail Mount

The system features DIN-rail mount chassis that facilitates fast installation of the EC900-FS6 to a DIN rail.

The DIN Rail mount kit includes the following:

- Din-rail mount bracket
- 2 screws

1. Use the provided mounting screws to attach the din-rail mount bracket to the rear side of the device.

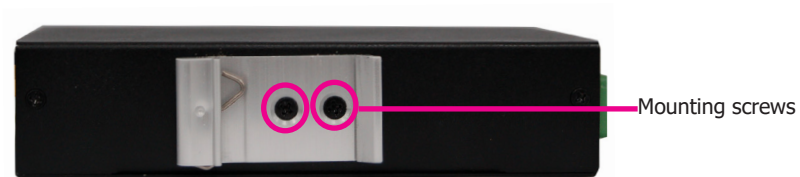

2. Install the device onto the rail.



Chapter 7 - Supported Software

Introduction

The platform is an embedded system that may be pre-loaded with Yocto 1.8 beta or Android 5.1 beta on the eMMC.

Download Images to eMMC with MFGTool

1. Set the dip switch SW5 to "Serial Downloader Mode": pins 7 on and 8 off.



2. Connect your PC and the system using a Micro USB cable.
3. Power on the system.

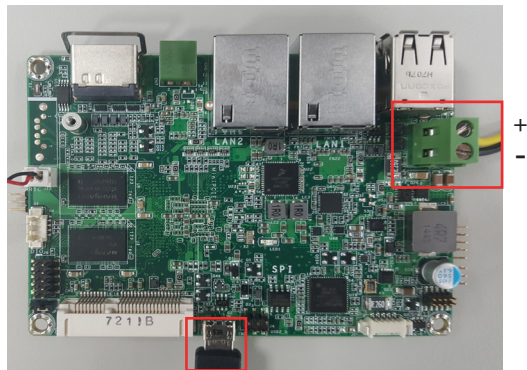

Micro USB Cable

4. Unzip the image package on your PC. Note the image package will be named to indicate the size of the eMMC memory and the OS. For example, if your system has 2G memory and is to be programmed an Android image, the package should be named as EC900-FS6_2G_ANDROID_MFGTool_180402_58.zip.
5. To program the Yocto image on the system board, execute the vbs file ("\\DualLite_core\yocto-emmc-fs053_DualLite-all_hdmi.vbs") to start the MfgTool User Interface.
6. To program the Android image on the system board, execute the vbs file ("\\DualLite_core\android-emmc-fs053_DualLite-all_hdmi.vbs") to start the MfgTool User Interface.
7. The left-hand side panel should show that a HID-compliant device is connected. Click "Start" to start the burning process. Wait until the completion of the burning process.

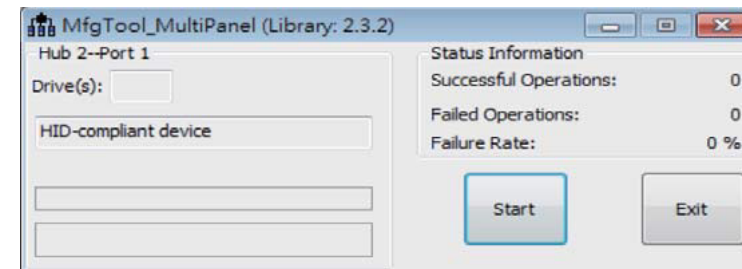

8. Click "Stop" to stop or to halt the process.

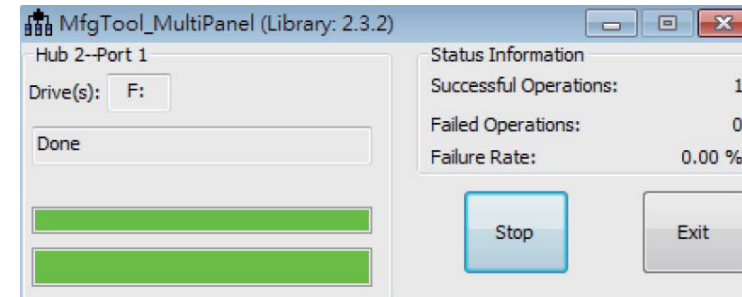

Important:

The adapter output voltage is 9~36V.

9. Set the dip switch SW5 to boot to the eMMC: pins 1, 2, 5, 6, 8 on and 3, 4, 7 off.



10. Power on the device again to reboot it into the system.

Download Uboot Images to SPI with MFGTool

1. Please complete the steps 1 to 8 in the above "Download Images to eMMC with MFGTool" first.
2. Set the dip switch SW5 to "Serial Downloader Mode": pins 7 on and 8 off.

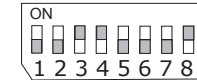

3. Connect your PC and the system using a Micro USB cable.



Important:

The adapter output voltage is 9~36V.

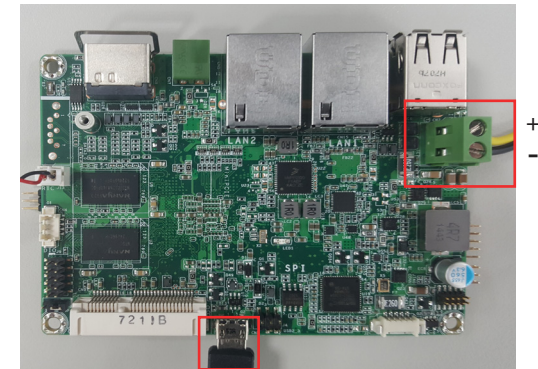

Micro USB Cable

4. Unzip the image package on your PC.
5. To program the Yocto image on the system board, execute the vbs file ("\\DualLite_core\yocto-spi-fs053_DualLite-uboot_hdmi.vbs") to start the MfgTool User Interface.
6. To program the Android image on the system board, execute the vbs file ("\\DualLite_core\android-spi-fs053_DualLite-uboot_hdmi.vbs") to start the MfgTool User Interface.
7. The left-hand side panel should show that a HID-compliant device is connected. Click "Start" to start the burning process. Wait until the completion of the burning process.

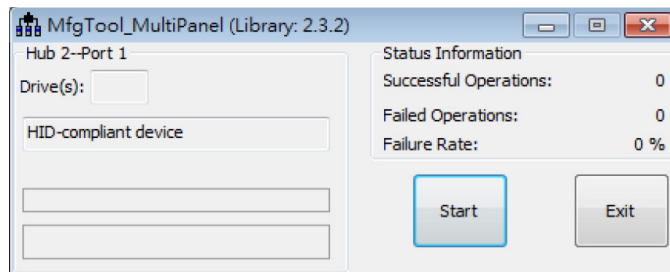

8. Click "Stop" to stop or to halt the process.

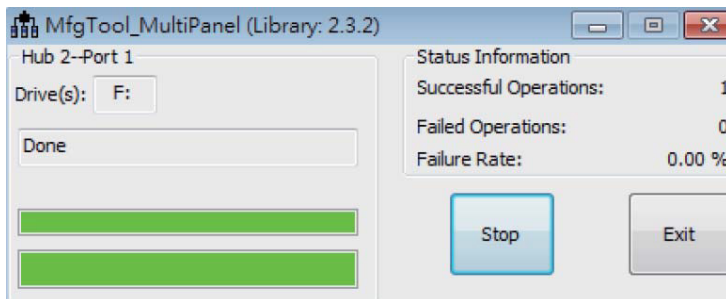

9. Set the dip switch SW5 to boot to the SPI flash: pins 4, 5, 8 on and 6,7 off.

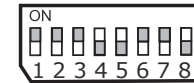

10. Power on the device again to reboot it into the system.

Software Features

General Support

(*) This feature depends on the NXP's support.

Component	Name	Base-Line Feature
General	OS Support	Yocto 1.8 - Kernel 3.14.52 (default preloaded on eMMC) Android 5.1.1 - Kernel 3.14.52
Misc	Firmware Upgrade (*)	MFGTool firmware update tool
	Utilities (*)	Hardware diagnostic utilities

Linux AP/API Support

(*) This feature depends on the NXP's support.

Component	Description	Detail
Linux	Yocto 1.8 - Kernel 3.14.52	It is an open-source project that delivers a set of tools which create operating system images for embedded Linux systems. Support X-11 Demo Image Only (*)
Linux AP/API	NXP i.MX6 Yocto 1.8 BSP Support X11 Window Support BitBake build tool	All library and utility should support (*). Source code package (support by request)
	Support I ² C, Watchdog and GPIO	Provide support console for i.MX6 platform
Android	Android 5.1.1 - Kernel 3.14.52	Support Demo Image
Android AP/API	NXP i.MX6 Android 5.1.1 NXP BSP Support Android AOSP launcher Support Android ADB shell Support Android APK install	All library, utility and Android apk should support (*). Source code package (support by request)
	Support I ² C, Watchdog and GPIO	Provide support console for i.MX6 platform.

Yocto Support

This feature depends on the NXP's support.

Component	Support Status
Yocto Version	1.8
Kernel Version	3.14.52
Window System	X11 without QT5 build
eMMC	Support eMMC boot, eMMC v5.1, Linux ext3 file system
Ethernet LAN1	Support "ping", "ifconfig" console commands verify, static IP/DHCP Dynamic IP, fixed MAC address.
Ethernet LAN2	Support "ping", "ifconfig" console commands verify, static IP/DHCP Dynamic IP, fixed MAC address. Due to LAN7500 is PCIe over USB2.0 Ethernet card, data transfer throughput limit is below 480Mbps (USB2.0 SPEC limitation).
USB 2.0	1. Support USB HID Keyboard and Mouse Device 2. Support USB Mass Storage by "mount" console command, EXT3/EXT4/ FAT filesystem
USB OTG	1. Support USB HID Keyboard and Mouse Device 2. Support USB Mass Storage by "mount" console command, EXT3/EXT4/ FAT filesystem 3. Support connect to PC to update image by i.MX6 MFGTool
HDMI Video Output	Support single display function, need to plug in HDMI cable before power on, resolution 1920x1080@60
DIO	Support read input voltage, set output voltage high/low status, control by Linux device node, 4 pins
Mini PCIe	Support "Ispci" console command for check PCIe card status. For standard product, we only port ENLi AP12356 WiFi/BT module.

Component	Support Status
UART1 - RS485	Support Loopback test, BR 115200 (need DFI Linux user space utility)
UART2 - RS422	Support Loopback test, BR 115200 (need DFI Linux user space utility)
SPI2 Nor-Flash	Support SPI2 Nor-Flash boot (Uboot image only)
RTC	Support Linux "date -s" and "hwclock -w" console commands to set system time
Thermal Sensor	Support read device temperature (degrees C) by Linux device node
Debug Serial Port	Support read Linux kernel debug log by serial port, use PC serial terminal tool (ex. PuTTY), BR 115200
Play Video	Support play MPEG4 file (need DFI Linux user space utility).
Watchdog	Support NXP utility "wdt_driver_test.out"(*) to test Watchdog reboot function
Package Manager	N/A. For standard product, we do not build in package manager.

Android Support

This feature depends on the NXP's support.

Component	Support Status
Android Version	5.1.1
Kernel Version	3.14.52
eMMC	Support eMMC boot, eMMC v5.1, Linux ext4 file system
Ethernet LAN1	<ol style="list-style-type: none"> 1. Support "ping", "ifconfig" console commands, and NXP Ethernet APP (*) 2. Support static IP/DHCP Dynamic IP, fixed MAC address 3. If both LAN1 Ethernet port and LAN2 Ethernet port are plugged-in with Ethernet cables, only the first Ethernet port plugged-in with Ethernet cable will connect to network. If the first Ethernet port plugged-in with Ethernet cable is unplugged, the second Ethernet port will connect to network automatically.
Ethernet LAN2	<ol style="list-style-type: none"> 1. Support "ping", "ifconfig" console commands, and NXP Ethernet APP (*) 2. Support static IP/DHCP Dynamic IP, fixed MAC address 3. If both LAN1 Ethernet port and LAN2 Ethernet port are plugged-in with Ethernet cables, only the first Ethernet port plugged-in with Ethernet cable will connect to network. If the first Ethernet port plugged-in with Ethernet cable is unplugged, the second Ethernet port will connect to network automatically.
USB 2.0	<ol style="list-style-type: none"> 1. Support USB HID Keyboard and Mouse Device 2. Support Android auto mount USB Mass Storage function (only one USB storage is available at a time. If second USB is plugged-in the USB cable, second USB is not available. If first USB is unplugged, second USB needs to be unplugged and re-plugged back to be available.) FAT32 filesystem only without multi-partition
USB OTG	<ol style="list-style-type: none"> 1. Support USB HID Keyboard and Mouse Device 2. Support Android auto mount USB Mass Storage function (only one USB storage is available at a time. If second USB is plugged-in the USB cable, second USB is not available. If first USB is unplugged, second USB needs to be unplugged and re-plugged back to be available.) FAT32 filesystem only without multi-partition 3. Support connect to PC to update image by i.MX6 MFGTool

Component	Support Status
HDMI Video Output	If users want to change HDMI resolution (i.e. 1920x1080), they need to modify kernel parameter to change LVDS resolution to 1920x1080 too.
DIO	1. Support read input voltage, set output voltage high/low status, control by Linux device node, 8 pins 2. Support DFI Android GPIO demo APP (support by request)
Mini PCIe	1. Support "busybox lspci" console command for check PCIe card status. 2. For standard product, we only port ENLi AP12356 WiFi/BT module.
UART1 - RS485	Support Loopback test, BR 115200 by DFI Android UART demo APP (support by request)
UART2 - RS422	Support Loopback test, BR 115200 by DFI Android UART demo APP (support by request)
SPI2 Nor-Flash	Support SPI2 Nor-Flash boot (Uboot image only)
RTC	Support Android->Settings->Date to set system time function.
Thermal Sensor	Support read device temperature (degrees C) by Android CPU-Z APP installed by user
Debug Serial Port	Support read Linux kernel debug log by serial port, use PC serial terminal tool (ex. PuTTY), BR 115200
Play Video	Support play MPEG4 file by Android AOSP Gallery APP.
Watchdog	Support adb shell command "am hang --allow-restart" to test Watchdog reboot function

Component	Support Status
WiFi/BT	<ol style="list-style-type: none"> Support AP12356 WiFi/BT module AP12356 WiFi: <ol style="list-style-type: none"> Support WiFi STA Mode (connect WiFi AP) by Android UI to enable/disable it. Support Soft AP Mode (enable DHCP/IPv4 routing) by Android UI to enable/disable it. Support Android UI to set up Soft AP information Support Android Airplane mode to disable WiFi function Not support STA mode and Soft AP mode enable at the same time Not support other WiFi modes, i.e. Wi-Fi Direct, Miracast, Wi-Fi TimeSync, etc. STA mode limitation: when plug-in wired LAN, STA mode will disconnect automatically by Android network framework limitation AP12356 BT: <ol style="list-style-type: none"> Support BT connected and enable/disable by Android UI Support BT files transfer by OPP profile using "Bluetooth File Transfer" tool. Support OPP, FTP, OBEX, SDAP profile only Not support other BT profiles which are not listed above Support Android Airplane mode to disable BT function
Android Build Type	ENG Build without SELinux
Android ADB	Support
Android Factory Reset	Support
Android Fastboot	Not support
Android OTA	Not support
Android CTS	Not support
Android GMS/GTS	Not support
Android Suspend	Not support suspend, set never to suspend by default.

Component	Support Status
Preload Android APPs	<ol style="list-style-type: none"> 1. AOSP Browser: Web Browser 2. AOSP Calculator: Calculator APP 3. AOSP Calendar: Calendar APP 4. AOSP Clock: Clock APP, support alarm wake-up 5. AOSP Contacts: function not ready, preload for 3G module test in the future 6. AOSP Dev Tools: develop test tool 7. AOSP Downloads: show downloads APP 8. AOSP Email: E-Mail APP 9. AOSP Gallery: Gallery APP (JPEG) 10. AOSP Messaging: Short Message Service (SMS) APP. Function not ready, preload for 3G module test in the future. 11. AOSP Music: Play music APP (MP3) 12. AOSP Phone: function not ready, preload for 3G module test in the future. 13. AOSP Settings: Android Settings APP 14. AOSP Sound Recorder: Sound Recorder APP. Function not ready, preload for AOSP Audio module test in the future 15. NXP Audio Route (*): function not ready, preload for Audio module test in the future. 16. NXP Ethernet (*): Ethernet settings APP. 17. Open-source Simple Explorer: File Explorer APP